

SafeLite

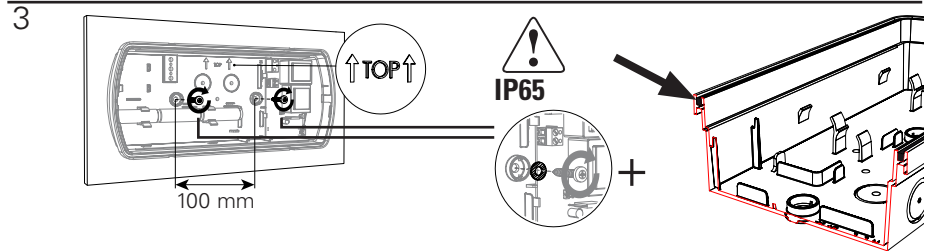

4a.

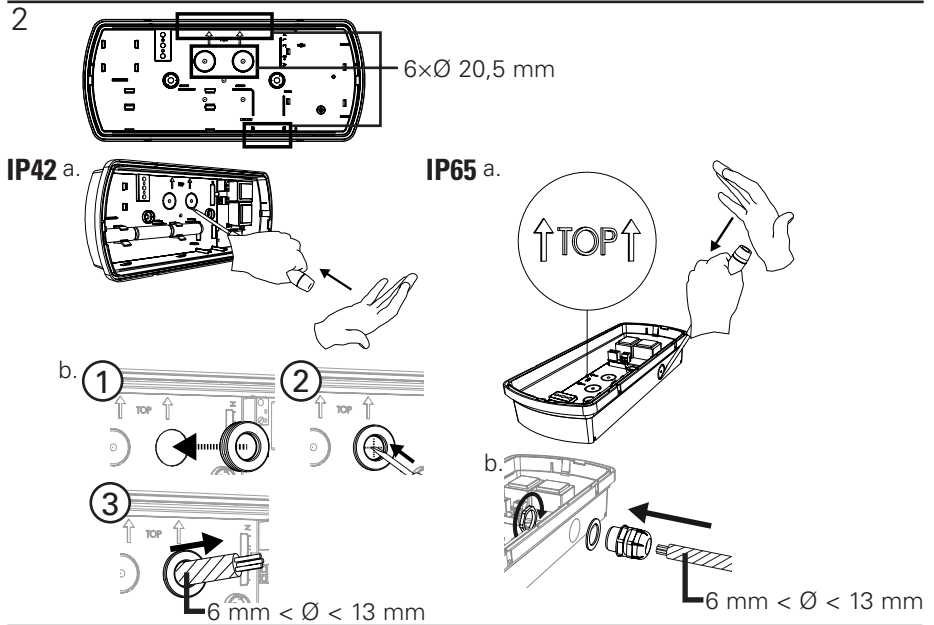
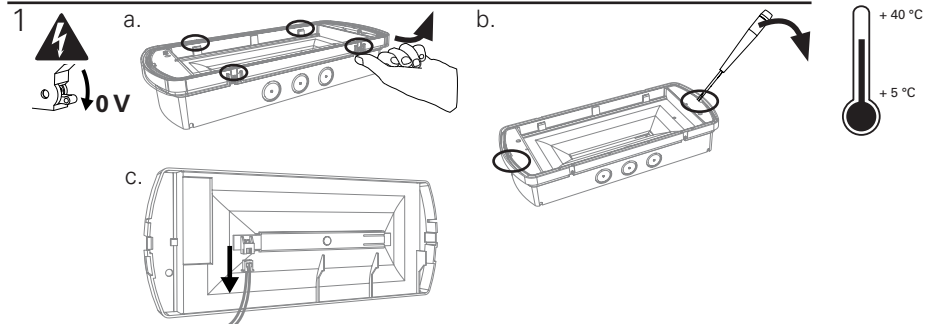
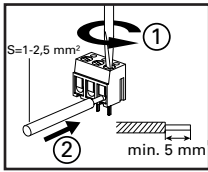

A Rigid or flexible wire

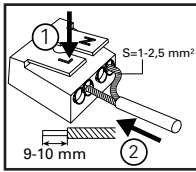
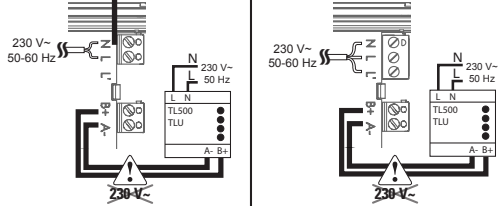

A Rigid or flexible wire

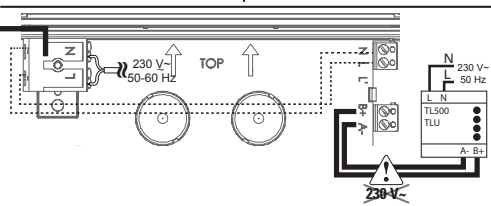

B

See manual
TLU
ZNO2016600
TL500
ZNO2016400

b.

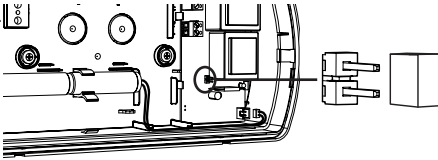

Non Maintained
Maintained

C

c.

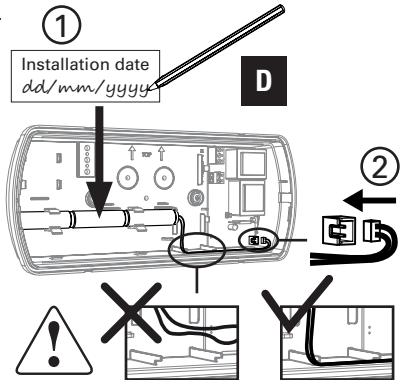

5

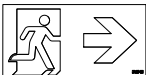

E Option

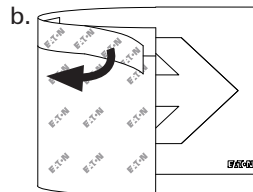
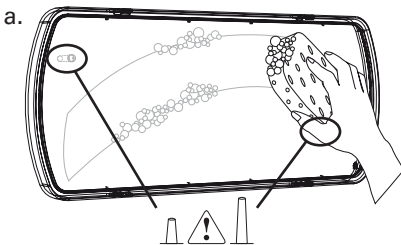

5 c.

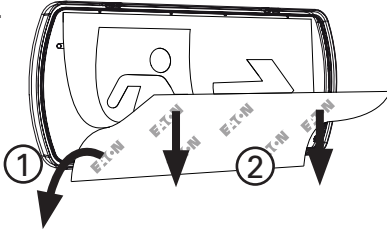

6 a.

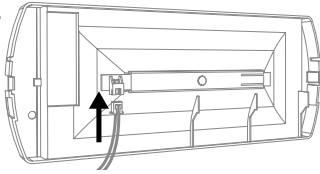

b.

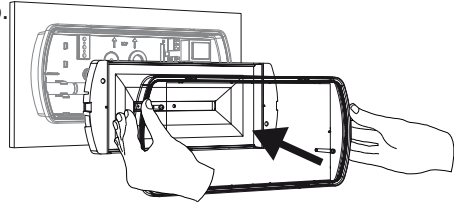

IK07

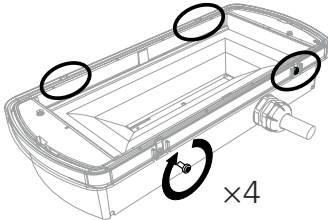

c.



A

IT Cavo rigido o flessibile
PT Fio rígido ou flexível
ES Hilo rígido o flexible
FR Fil souple ou rigide
EN Rigid or flexible wire
DE Starre oder flexible Leitung

B

cf. manuale
 Ver manual
 Voir manuel
 See manual
 Sehen Betriebsanleitung

C

Non permanente/Permanente
 Não Mantido/Mantido
 Non Permanente/Permanente
 Non maintenu/Maintenu
 Non Maintained/Maintained
 Bereitschaftslicht/Dauerlicht

D

Data installazione
 Data instalação
 Fecha instalación
 Date installation
 Installation date
 Installationsdatum

E

Opzione
 Opção
 Opción
 Option
 Option
 Option

F

Prima carica
 Antes da primeira utilização
 Primer uso
 Avant toute utilisation
 Before use
 Vor Gebrauch



Non sostituibili/
 Não substituíveis/
 No sustituibles/
 Non remplaçables/
 Not replaceable/
 Nicht auswechselbaren

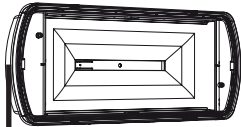

B Non Maintained/
 Maintained

Light output
 Battery duration **G**

G

IT Flusso luminoso - Autonomia batteria
PT Fluxo luminoso - Autonomia bateria
ES Flujo luminoso - Autonomia batería
FR Flux lumineux - Autonomie batterie
EN Light output - Battery duration
DE Lichtstrom - Nennbetriebsdauer

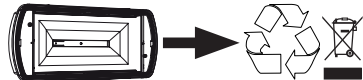

Eaton
 EMEA Headquarters
 Route de la Longeraie 7
 1110 Morges, Switzerland
 Eaton.eu

ZNO2036600 PrK - 10/2016

© 2016 Eaton
 All Rights Reserved.

Eaton is a registered trademark.

All trademarks are property
 of their respective owners.



EATON

Powering Business Worldwide